

Automatic Clamping Paint Shaker

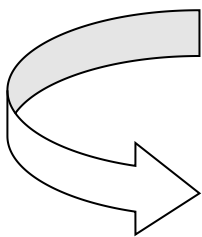
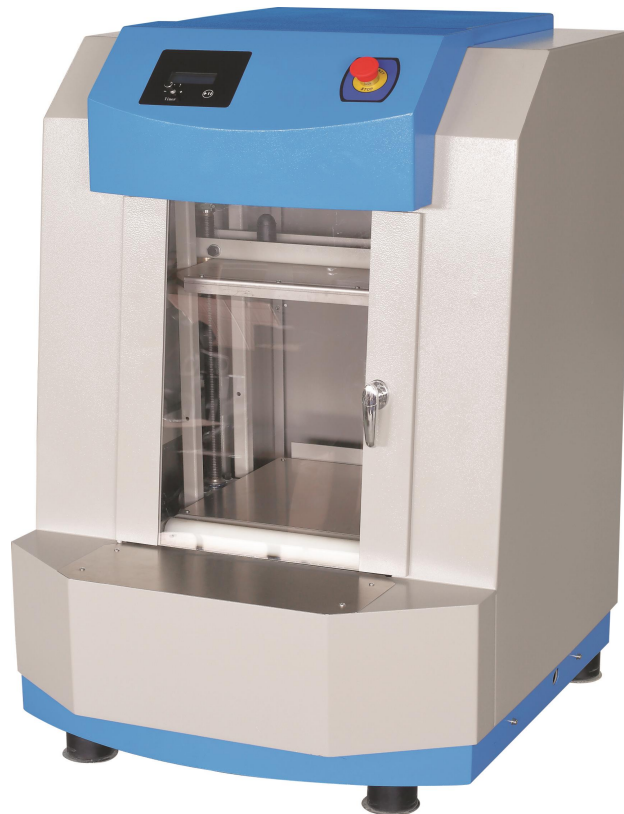

User Manual

CONTENTS

	Page No.
WARNING	3
1. USER MANUAL INTRODUCTION	4
2. TECHNICAL SPECIFICATIONS	4
3. TERMS OF WARRANTY	4
4. SAFETY INSTRUCTIONS	5
5. PREPARATION BEFORE USE	6
6. OPERATION INSTRUCTION	7
7. PARAMETER SETTING INSTRUCTION	8
8. DEFAULT PARAMETERS.....	8
9. TROUBLE SHOOTING	8
10. MAINTENANCE OF MACHINE	10
11. .INDICATOR LIGHT, WIRING POSITION DIAGRAM	10
12. SHAKER MACHINE WIRING DIAGRAM	11

WARNING

Dear Customers,

Please note below points before electrifying the machine:

1. Machine should be laid to the ground safely, which means the four legs of the machines should be landed stably, and the body of the machine cannot shake or move. This will reduce the noise from the machine's operation, and prolong the life of the machine.

2. Make sure you take out the fixing screw rods which just used for fixation during transportation before running the machine. (See below picture). Otherwise, our company shall not be responsible for any consequences caused.

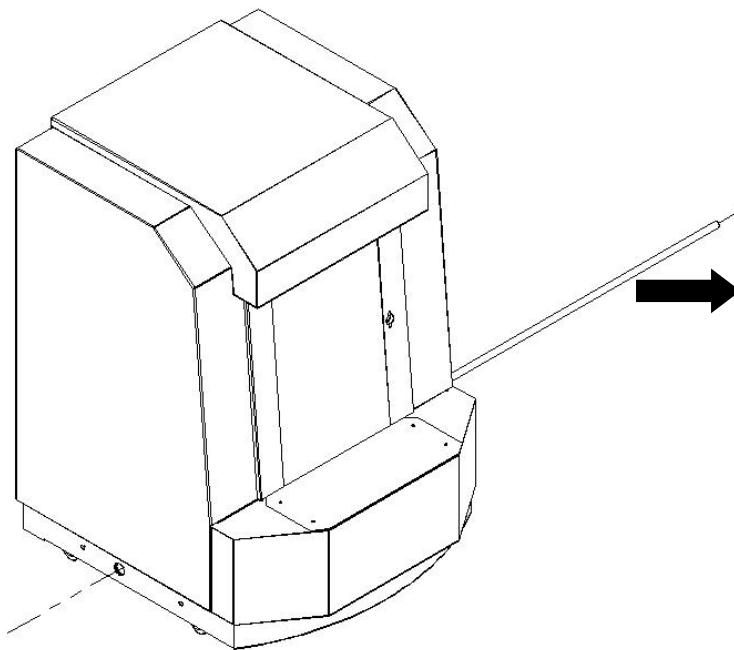

Caution: Take out this screw rod before running the machine. Otherwise, it will damage the machine.

3. For your safety, please make sure the machine is grounding reliably.

1. USER MANUAL INTRODUCTION



Purpose and use of this manual

It is aimed at the machine operators and installers, who must have the necessary training and professional skill to use similar automatic machines.

For the safe use of the machine, it is important:

1. To familiarize yourself with the structure and content.
2. To read the safety chapter in detail and make sure you understand all the instructions.

2. TECHNICAL SPECIFICATIONS

Time of Shaking: 1min-9min

Size of Shaking can: 0.5~20L

Load of Shaking can: 1~30KG

Frequency of shaking: 710 times/min

Height of Shaking can: 80~410mm

Power Supply: 220V±10% 50HZ

Rated Power: 750W

3. TERMS OF WARRANTY

Limited Warranty: We offer a period of one year warranty for each equipment. Within guarantee period, we can help you judge the fault according to the failure phenomenon by E-mail. and send replacement part to you. If the fault has been caused by mis-use or abnormal conditions of operation, repairs will be billed at a normal cost in this case. An estimate will be submitted before repair work is started in case requested.

The user must keep the machine in a proper working condition. Broken parts and accessories must be replaced with original appropriate parts of the machine.

The manufacturer's warranty expires under below conditions:

Twelve months after date of invoicing;

In case of inexpert use;

In case of non-original spare parts are used;

In case of repairing/adaptation of the machine without written approval and/ or by unauthorized personnel;

In case of non-fulfillment of the maintenance, operation or other instructions reflected in this manual.

4. SAFETY INSTRUCTIONS

Please read the instructions carefully before installing and operating the machine, as a personal safety measure as well as to avoid needless damage to the machine.

Safety requirements:

Since the mis-use and wrong operation might cause accidents, the equipment should be operated and maintained by trained personnel only.

Power Supply:

110-120 VOLTAGE: When the Shaker is connected to a voltage of 110-120 Volt, the source current must be more than 32A (with the leakage current being 30mA).

220-240 VOLTAGE: When the Shaker is connected to a voltage of 220-240 Volt, the source current must be more than 16A (with the leakage current being 30mA).

Safe use of the machine:

1. The installation and maintenance of the machine must be performed by a specialized technician.
2. Please properly secure the outside panel of the machine to prevent any physical injuries.
3. Prior to any maintenance and inspection of the machine, disconnect the power cord from the outlet mains. Make sure that the machine cannot be started unexpectedly.
4. Do not leave any tools inside in the machine after maintenance.
5. Check that the environment where the machine is installed conforms to local regulations (a permit issued by local authority may be necessary) and avoid dangerous concentration of paint cans around the equipment. It's forbidden to stock inflammable materials or other materials inside the machine. It's forbidden to use free flames, incandescent objects or equipment that are able to create sparks in the local where the machine is installed.
6. It is recommended to install a ventilation system to guarantee that the concentration of dangerous vapour around all electrical components is less than 30%.
7. Take the paint can out from the machine at the end of the work. If you don't use the machine any more, cut off its power supply.
8. In the locations where the machine is installed, the prohibition symbols "No Smoking/ Burning" have to be placed at 5 meters from the machine. The equipment is constructed for the treatment of non-explosion materials. It is forbidden to use this machine with inflammable or explosion vapors.

Warning:

1. Avoid to operate the machine overload.
2. Never use a load with a weight over 35kg,
3. Don't switch off the machine with the can inside.
4. Do not place any damaged packaging in the machine. Running the machine with damaged packaging is at "user's" risk. Already damaged packaging may cause damage to your machine. During the maintenance respect the security rules and the procedure described in its Paragraph.

5. The machine is to be operated only by trained personnel. We shall not be liable for any damage or injury caused by non-compliance with the “user” and ” safety” Regulations presented in this manual.
6. Before you put the paint can inside the machine, please check whether the paint can is distorted or leaking. If it's distorted or leaking, you shouldn't put it inside the machine.
7. If the paint can has a handle, make sure the handle is firm, otherwise, disconnect it.
8. Before shaking, please check whether the paint can be located at center place of the bottom plate. If it's not at the center place, adjust it to the center place.
9. Before starting the machine, please check whether there are objects that block the machine's shaking. If there are such objects, take them out of the machine before you start .

5. PREPARATION BEFORE USE

Please know well the following points to make sure smooth operation after machine is installed.

1. Check if the power switch of machine is at off state before plugging in.
2. Make sure Emergency button is released, and the transparent door is closed.
3. Canister must be well sealed and without damages. It should be placed on the centre of loading plate.

Control panel introduction:

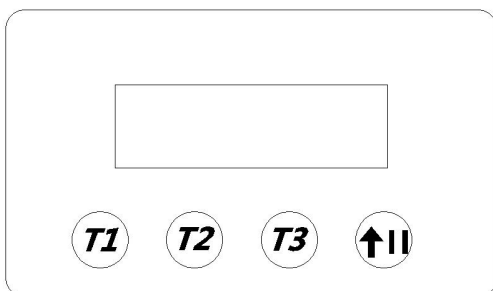

T1 button (1 min button) : press this button, the clamping plate automatically clamps the canister, and finish appointed 1 minute mixing.

T2 button (3 min button) : press this button, the clamping plate automatically clamps the canister, and finish appointed 3 minutes mixing.

T3 button (5 min button) : press this button, the clamping plate automatically clamps the canister, and finish appointed 5 minutes mixing.

T1+T2: Press T1+T2 at the same time , clamping plate automatically clamps the canister, and finish appointed 4 minutes time mixing.

T1+T3: Press T1+T3 at the same time , clamping plate automatically clamps the canister, and finish appointed 6 minutes time mixing.

T2+T3: Press T2+T3 at the same time , clamping plate automatically clamps the canister, and finish appointed 8 minutes time mixing.

T1+T2+T3: Press T1+T2+T3 at the same time , clamping plate automatically clamps the canister, and finish appointed 9 minutes time mixing.



Button (Stop, lift button) :

A). When machine is in the state of "Mixing" or "Clamping", LCD shows "Mixing" or "Clamping". At this time, press this button, machine will stop mixing or clamping and lift the clamping plate.

B). When machine is in the "ready" state, LCD shows "Ready". At this time, press this button, the clamping plate will lift up, and stop when you release the button.

Attention:

The timer buttons are only available for setting when the machine is under state of "Ready".



Button: Emergency button:

Press this button to stop machine if some abnormality happened. Turn clockwise this button to reinitialize machine to let the clamping plate move up to initial place.

6. OPERATION INSTRUCTION

The machine applies fully automatic intelligent control, which is easy to operate. Here are the operation details.

1. Plug in and switch on the power at back of the machine. LCD will show the serial no. Of the machine, and start to initialize. After initialization, LCD shows "Ready". It means the machine is ready for working.
2. Open the transparent door, place the canister onto the plate, and push to the centre of loading plate. If the canister has handle, then use spring hook to draw the handle. Then shut the door.
3. According to the mixing time needed, press the time button to set up the time. Now, the clamping plate automatically moves downwards. LCD shows "Clamping" & "Mixing time". After the canister clamps for 2~3 seconds, the machines starts high speed shaking mixing. LCD shows "Mixing" & the balance mixing time (counting down).
4. When time is up, the machine stops mixing. After 3 seconds, the clamping plate automatically lift up and loosen the canister. LCD shows "Pls wait", and the plate will lift up to a initial height.
5. The LCD shows "finish mixing", open the door and take out the pail of paint.



(**Attention:** if need to mix one more time, you need to open the door then close again, otherwise, it won't mix)

6. Everyday after use, please clean the dirty things or spilled paints. keep the inside machine and screw rods clean.

Attention:

1. No mixing with empty load!
2. Frequent start the machine is forbidden. The machine could not be started over 20 times within one hour.
3. Please press "Emergency" button in case there is any accidental noise. Find out the reasons, and solve the trouble. After this, you can restart again.
4. If you come across any failure during initialization or clamping, please press "Emergency" button to reinitialize the machine.

7. PARAMETER SETTING INSTRUCTION

1. Press the button  and turn on the power in the same time until the LCD shows “big can pressure”, then release the button and press “ T3” button to choose the parameter you want to set.
2. When you press "T1" button, the number will add "1" each click. If you don't release the “T1” button, the number will increase continuous automaticall; When you press "T2" button, the number will reduce "1" each click. If you don't release the “T2” button, the number will decrease continuous automaticall; pess  to save the parameter when finish setting.

You can set the parameter of item as below:

1. Big can force: for the can with height more than 300mm
2. Middle can force: for the can with height 110-300mm
3. Small can force: for the can with height less than 110mm
4. Move-up speed: upper clamping plate move up speed
5. Move-up force: upper clamping plate move up distance
6. Move-down speed: upper clamping plate move down speed
7. Move-down force: upper clamping plate move down distance
8. Reset speed: upper clamping plate move up speed when turn on the machine
9. Reset force: upper clamping plate move up distance when turn on the machine
10. Language select: only Chinese or English can be choose

Noted: All above parameter is relative value rather than absolute value. Please adjust the parameter according to the actual situation on site. The number bigger, the pressure bigger, the speed faster.

8. DEFAULT PARAMETERS

Big can force	50
Middle can force	50
Small can force	50
Move-up speed	90
Move-up force	60
Move-down speed	90
Move-down force	45
Reset speed	90
Reset force	55

9. TOUBLE SHOOTING

Failure	Reason analysis	Solution
Shaking starts immediately when power is on	1) Electronic board broken 2) solid state relay breaks.	Disconnect no. 3 or 4 of solid state relay. If the machine stops shaking, means electronic board broken. If it's still shaking, means solid state relay breaks.

No mixing	<ul style="list-style-type: none"> 1) electronic board broken 2) solid state relay broken 3) shaking motor broken 4) Motor capacitance broken 5) motor wire breaks. 	<p>1. Short circuit no. 1 and 2 of solid state relay, and see if it's shaking. (1) If it's not shaking, then observe if there is "buzz" noise when motor is electrified. - If yes, replace the motor capacitance. And replace the motor if still not shaking after replacing the motor capacitance . - If no, please check wire. If it's normal, then change motor. (2). If it's shaking, check D11 light of the electronic board when LCD shows "mixing". If D11 light is on, means no problem of the electronic board. If D11 off, means electronic board broken.</p>
No display on LCD	<ul style="list-style-type: none"> 1) LCD broken 2) Flat cable breaks 3) Electronic board broken 4). Fuse broken 5)Transformer broken 	<p>1. Check Led 2 and D5 light on the electronic board - If Led 2 not twinkle and D5 off, then check the transformer and fuse. - If Led 2 twinkle and D5 on, and there's backlight on the LCD , then replace the LCD. - If Led 2 twinkle and D5 on, and there's no backlight on the LCD , then replace the flat cable. If after replacing flat cable, there still no display on LCD, then replace the electronic board.</p> <p>2.Please check the transformer with multimeter.</p>
Keyboard doesn't work	<ul style="list-style-type: none"> 1) Buttons broken 2) Connecting cable breaks 3) Electronic board broken 	<p>1. If it's only a certain buttons don't work, then check if that button is broken. 2. If all buttons don't work, then check flat cable. If flat cable no problem, then replace the electronic board.</p>
Shaking is weak	Belt loose	Adjust the belt accordingly.
Clamping system failure	<ul style="list-style-type: none"> 1) Clamping motor broken 2) Electronic board broken 3) Synchronous belt broken 4) Parameter incorrect 5) Sensor broken 	<ul style="list-style-type: none"> 1. Check the carbon brush of the clamping motor. 2. Replace the electronic board. 3. Replace the synchronous belt. 4. Reset the parameter 5. Replace the sensor

10. MAINTENANCE OF MACHINE

To safeguard the normal operation of the machine, prolong its life, utilize its economy value to the maximum, please kindly insist in the daily maintenance work.

1. Only professionals are allowed to disassemble the machine.
2. Lubricate the screw rod and guide pillar every three months.
3. Solve the problem in time.

11. INDICATOR LIGHT, WIRING POSITION DIAGRAM

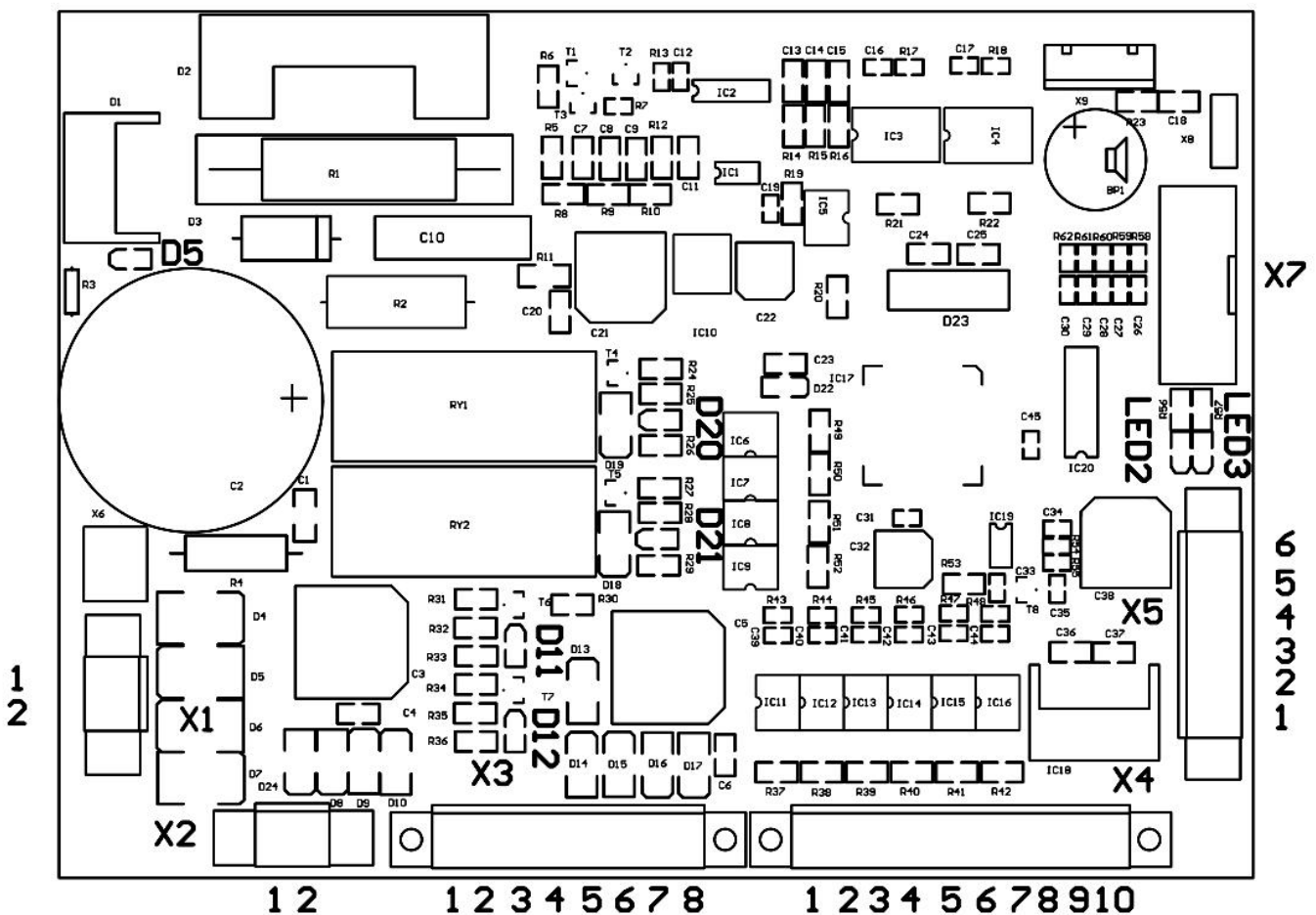

Led/ indicator light instruction

D5 : Direct current motor power indicator

D11: Mixing motor working indicator, if the light is on but mixing motor not work, it's possible that the solid-state relay or the mixing motor broken.

D13: spare

D20 : when clamping plate move down, the light is on.

D21 : When clamping plate move up, the light is on.

LED2: The light twinkle means the CPU is running. The light off, the power may have problem. The light on but not twinkle, CPU system may have problem.

12. SHAKER MACHINE WIRING DIAGRAM

